

DO-27 Plastic-Encapsulate Diodes

1.5KE SERIES Transient Voltage Suppressor Diodes

Features

- P_{PP} 1500W
- V_{RWM} 5.5V- 459V
- Glass passivated chip

Applications

- Clamping Voltage

Marking

- 1.5KE XXA/CA
- XX : From 6.8 To 540

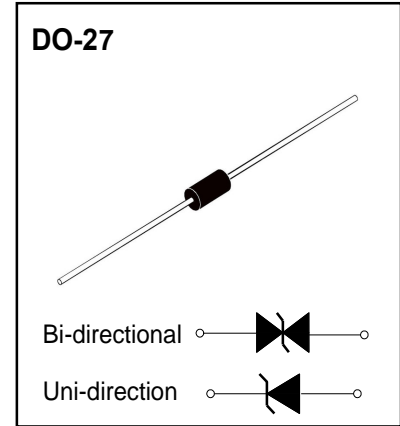

Limiting Values (Absolute Maximum Rating)

Item	Symbol	Unit	Conditions	Max
Peak pulse power dissipation	P _{PPM}	W	with a 10/1000us waveform	1500
Peak pulse current (1)	I _{PPM}	A	with a 10/1000us waveform	See Next Table
Power dissipation	P _D	W	On infinite heat sink at T _L =75°C	6.5
Peak forward surge current(2)	I _{FSM}	A	8.3 ms single half sine-wave unidirectional only	200
Operation Junction and Storage Temperature Range	T _J , T _{STG}	°C		-55 ~ +150

Electrical Characteristics (T_a=25°C Unless otherwise specified)

Item	Symbol	Unit	Conditions	Max
Maximum instantaneous forward Voltage (3)	V _F	V	at 25A for unidirectional only	3.5/5.0
Thermal resistance	R _{θJA}	°C/W	junction to ambient	75
	R _{θJL}	°C/W	junction to lead	15.4

Notes:

- (1) Non-repetitive current pulse, per Fig. 3 and derated above T_A = 25°C per Fig.2.
- (2) Mounted on 0.2 x 0.2" (5.0 x 5.0 mm) copper pads to each terminal
- (3) VF<3.5V for devices of VBR<200V and VF<5.0V for devices of VBR>201V

Electrical Characteristics ($T_A=25^{\circ}\text{C}$ unless otherwise noted)

Part Number(U ni)	Part Number(Bi)	Breakdown Voltage $V_{BR}@I_T$			Maximum Reverse Leakage $I_R@V_{WM}(\mu A)$	Working Peak Reverse Voltage $V_{RWM}(V)$	Maximum Reverse Surge Current IPP (A)	Maximum Clamping Voltage $V_c@I_{PP}(V)$	Maximum Temperature Coefficient of $V_{BR}(\%/^{\circ}\text{C})$
		Min(V)	Max (V)	$I_T(\text{mA})$					
1.5KE6.8	1.5KE6.8C	6.12	7.48	10	1000	5.50	139	10.8	0.057
1.5KE6.8A	1.5KE6.8CA	6.45	7.14	10	1000	5.80	143	10.5	0.057
1.5KE7.5	1.5KE7.5C	6.75	8.25	10	500	6.05	128	11.7	0.061
1.5KE7.5A	1.5KE7.5CA	7.13	7.88	10	500	6.40	133	11.3	0.061
1.5KE8.2	1.5KE8.2C	7.38	9.02	10	200	6.63	120	12.5	0.065
1.5KE8.2A	1.5KE8.2CA	7.79	8.61	10	200	7.02	124	12.1	0.065
1.5KE9.1	1.5KE9.1C	8.19	10.0	1.0	50	7.37	109	13.8	0.068
1.5KE9.1A	1.5KE9.1CA	8.65	9.55	1.0	50	7.78	112	13.4	0.068
1.5KE10	1.5KE10C	9.00	11.0	1.0	10	8.10	100	15.0	0.073
1.5KE10A	1.5KE10CA	9.50	10.5	1.0	10	8.55	103	14.5	0.073
1.5KE11	1.5KE11C	9.90	12.1	1.0	5.0	8.92	92.6	16.2	0.075
1.5KE11A	1.5KE11CA	10.5	11.6	1.0	5.0	9.40	96.2	15.6	0.075
1.5KE12	1.5KE12C	10.8	13.2	1.0	5.0	9.72	86.7	17.3	0.076
1.5KE12A	1.5KE12CA	11.4	12.6	1.0	5.0	10.2	89.8	16.7	0.078
1.5KE13	1.5KE13C	11.7	14.3	1.0	5.0	10.5	78.9	19.0	0.081
1.5KE13A	1.5KE13CA	12.4	13.7	1.0	5.0	11.1	82.4	18.2	0.081
1.5KE15	1.5KE15C	13.5	16.5	1.0	1.0	12.1	68.2	22.0	0.084
1.5KE15A	1.5KE15CA	14.3	15.8	1.0	1.0	12.8	70.8	21.2	0.084
1.5KE16	1.5KE16C	14.4	17.6	1.0	1.0	12.9	63.8	23.5	0.086
1.5KE16A	1.5KE16CA	15.2	16.8	1.0	1.0	13.6	66.7	22.5	0.086
1.5KE18	1.5KE18C	16.2	19.8	1.0	1.0	14.5	56.6	26.5	0.088
1.5KE18A	1.5KE18CA	17.1	18.9	1.0	1.0	15.3	59.5	25.2	0.089
1.5KE20	1.5KE20C	18.0	22.0	1.0	1.0	16.2	51.5	29.1	0.090
1.5KE20A	1.5KE20CA	19.0	21.0	1.0	1.0	17.1	54.2	27.7	0.090
1.5KE22	1.5KE22C	19.8	24.2	1.0	1.0	17.8	47.0	31.9	0.092
1.5KE22A	1.5KE22CA	20.9	23.1	1.0	1.0	18.8	49.0	30.6	0.092
1.5KE24	1.5KE24C	21.6	26.4	1.0	1.0	19.4	43.2	34.7	0.094
1.5KE24A	1.5KE24CA	22.8	25.2	1.0	1.0	20.5	45.2	33.2	0.094
1.5KE27	1.5KE27C	24.3	29.7	1.0	1.0	21.8	38.4	39.1	0.096
1.5KE27A	1.5KE27CA	25.7	28.4	1.0	1.0	23.1	40.0	37.5	0.096
1.5KE30	1.5KE30C	27.0	33.0	1.0	1.0	24.3	34.5	43.5	0.097
1.5KE30A	1.5KE30CA	28.5	31.5	1.0	1.0	25.6	36.2	41.4	0.097
1.5KE33	1.5KE33C	29.7	36.3	1.0	1.0	26.8	31.4	47.7	0.098
1.5KE33A	1.5KE33CA	31.4	34.7	1.0	1.0	28.2	32.8	45.7	0.098
1.5KE36	1.5KE36C	32.4	39.6	1.0	1.0	29.1	28.8	52.0	0.099
1.5KE36A	1.5KE36CA	34.2	37.8	1.0	1.0	30.8	30.1	49.9	0.099

Electrical Characteristics ($T_A=25^{\circ}\text{C}$ unless otherwise noted)

Part Number(Uni)	Part Number(Bi)	Breakdown Voltage $V_{BR}@I_T$			Maximum Reverse Leakage $I_R @ V_{WM} (\mu A)$	Working Peak Reverse Voltage $V_{RWM} (V)$	Maximum Reverse Surge Current IPP (A)	Maximum Clamping Voltage $V_c @ I_{PP} (V)$	Maximum Temperature Coefficient of $V_{BR} (\%/^{\circ}\text{C})$
		Min(V)	Max (V)	$I_T(\text{mA})$					
1.5KE39	1.5KE39C	35.1	42.9	1.0	1.0	31.6	26.6	56.4	0.100
1.5KE39A	1.5KE39CA	37.1	41.0	1.0	1.0	33.3	27.8	53.9	0.100
1.5KE43	1.5KE43C	38.7	47.3	1.0	1.0	34.8	24.2	61.9	0.101
1.5KE43A	1.5KE43CA	40.9	45.2	1.0	1.0	36.8	25.3	59.3	0.101
1.5KE47	1.5KE47C	42.3	51.7	1.0	1.0	38.1	22.1	67.8	0.101
1.5KE47A	1.5KE47CA	44.7	49.4	1.0	1.0	40.2	23.1	64.8	0.101
1.5KE51	1.5KE51C	45.9	56.1	1.0	1.0	41.3	20.4	73.5	0.102
1.5KE51A	1.5KE51CA	48.5	53.6	1.0	1.0	43.6	21.4	70.1	0.102
1.5KE56	1.5KE56C	50.4	61.8	1.0	1.0	45.4	18.6	80.5	0.103
1.5KE56A	1.5KE56CA	53.2	58.8	1.0	1.0	47.8	19.5	77.0	0.103
1.5KE62	1.5KE62C	55.8	68.2	1.0	1.0	50.2	16.9	89.0	0.104
1.5KE62A	1.5KE62CA	58.9	65.1	1.0	1.0	53.0	17.6	85.0	0.104
1.5KE68	1.5KE68C	61.2	74.8	1.0	1.0	55.1	15.3	98.0	0.104
1.5KE68A	1.5KE68CA	64.6	71.4	1.0	1.0	58.1	16.3	92.0	0.104
1.5KE75	1.5KE75C	67.5	82.5	1.0	1.0	60.7	13.9	109	0.105
1.5KE75A	1.5KE75CA	71.3	78.8	1.0	1.0	64.1	14.6	104	0.105
1.5KE82	1.5KE82C	73.8	90.2	1.0	1.0	66.4	12.7	118	0.105
1.5KE82A	1.5KE82CA	77.9	86.1	1.0	1.0	70.1	13.3	113	0.105
1.5KE91	1.5KE91C	81.9	100.0	1.0	1.0	73.7	11.5	131	0.106
1.5KE91A	1.5KE91CA	86.5	95.5	1.0	1.0	77.8	12.0	125	0.106
1.5KE100	1.5KE100C	90.0	110	1.0	1.0	81.0	10.4	144	0.106
1.5KE100A	1.5KE100CA	95.0	105	1.0	1.0	85.5	10.9	137	0.106
1.5KE110	1.5KE110C	99.0	121	1.0	1.0	89.2	9.5	158	0.107
1.5KE110A	1.5KE110CA	105	116	1.0	1.0	94.0	9.9	152	0.107
1.5KE120	1.5KE120C	108	132	1.0	1.0	97.2	8.7	173	0.107
1.5KE120A	1.5KE120CA	114	126	1.0	1.0	102	9.1	165	0.107
1.5KE130	1.5KE130C	117	143	1.0	1.0	105	8.0	187	0.107
1.5KE130	1.5KE130CA	124	137	1.0	1.0	111	8.4	179	0.107
1.5KE150	1.5KE150C	136	165	1.0	1.0	121	7.0	215	0.108
1.5KE150A	1.5KE150CA	143	158	1.0	1.0	128	7.2	207	0.106
1.5KE160	1.5KE160C	144	176	1.0	1.0	130	6.5	230	0.106
1.5KE160A	1.5KE160CA	152	168	1.0	1.0	136	6.8	219	0.108
1.5KE170	1.5KE170C	153	187	1.0	1.0	138	6.1	244	0.108
1.5KE170A	1.5KE170CA	162	179	1.0	1.0	145	6.4	234	0.108
1.5KE180	1.5KE180C	162	198	1.0	1.0	146	5.8	258	0.108
1.5KE180A	1.5KE180CA	171	189	1.0	1.0	154	6.1	246	0.108

Electrical Characteristics ($T_A=25^{\circ}\text{C}$ unless otherwise noted)

Part Number(Uni)	Part Number(Bi)	Breakdown Voltage $V_{BR}@I_T$			Maximum Reverse Leakage $I_R @ V_{WM} (\mu A)$	Working Peak Reverse Voltage $V_{RWM} (V)$	Maximum Reverse Surge Current IPP (A)	Maximum Clamping Voltage $V_C @ I_{PP} (V)$	Maximum Temperature Coefficient of $V_{BR} (\%/^{\circ}\text{C})$
		Min(V)	Max (V)	IT(mA)					
1.5KE200	1.5KE200C	180	220	1.0	1.0	162	5.2	287	0.108
1.5KE200A	1.5KE200CA	190	210	1.0	1.0	171	5.5	274	0.108
1.5KE220	1.5KE220C	198	242	1.0	1.0	175	4.4	344	0.108
1.5KE220A	1.5KE220CA	209	231	1.0	1.0	185	4.6	328	0.108
1.5KE250	1.5KE250C	225	275	1.0	1.0	202	4.2	360	0.110
1.5KE250A	1.5KE250CA	237	263	1.0	1.0	214	4.4	344	0.110
1.5KE300	1.5KE300C	270	330	1.0	1.0	243	3.5	430	0.110
1.5KE300A	1.5KE300CA	285	315	1.0	1.0	256	3.6	414	0.110
1.5KE350	1.5KE350C	315	385	1.0	1.0	284	3.0	504	0.110
1.5KE350A	1.5KE350CA	333	368	1.0	1.0	300	3.1	482	0.110
1.5KE400	1.5KE400C	360	440	1.0	1.0	324	2.6	574	0.110
1.5KE400A	1.5KE400CA	380	420	1.0	1.0	342	2.7	548	0.110
1.5KE440	1.5KE440C	396	484	1.0	1.0	356	2.4	631	0.110
1.5KE440A	1.5KE440CA	418	462	1.0	1.0	376	2.5	602	0.110
1.5KE480	1.5KE480C	432	528	1.0	1.0	389	2.19	686	0.110
1.5KE480A	1.5KE480CA	456	504	1.0	1.0	408	2.28	658	0.110
1.5KE510	1.5KE510C	459	561	1.0	1.0	413	2.06	729	0.110
1.5KE510A	1.5KE510CA	485	535	1.0	1.0	434	2.15	698	0.110
1.5KE540	1.5KE540C	486	594	1.0	1.0	437	1.94	772	0.110
1.5KE540A	1.5KE540CA	513	567	1.0	1.0	459	2.03	740	0.110

Typical Characteristics

FIG1: Peak Pulse Power Rating Curve

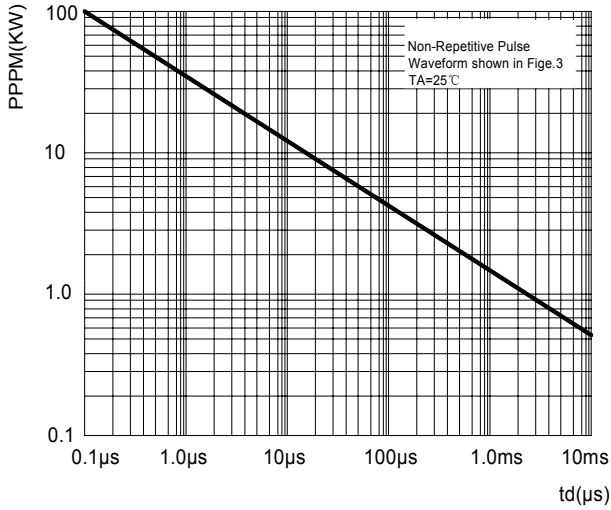

FIG2: Pulse Power or Current vs. Initial Junction Temperature

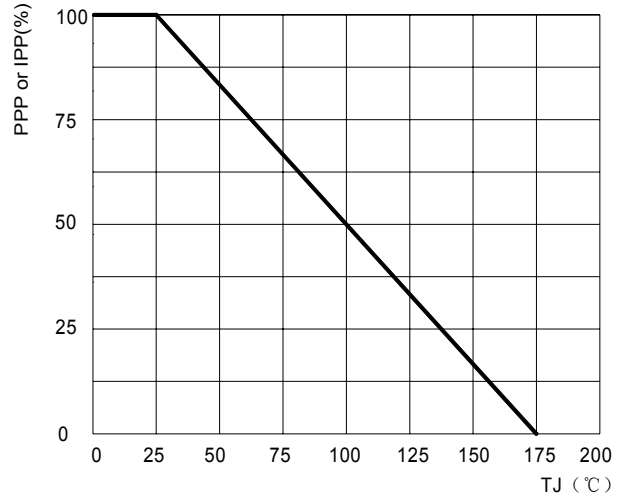

FIG3: Pulse Waveform

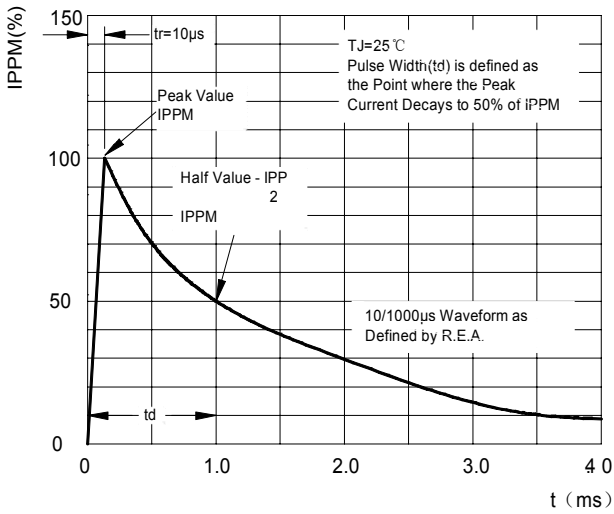

FIG4: Power Derating Curve

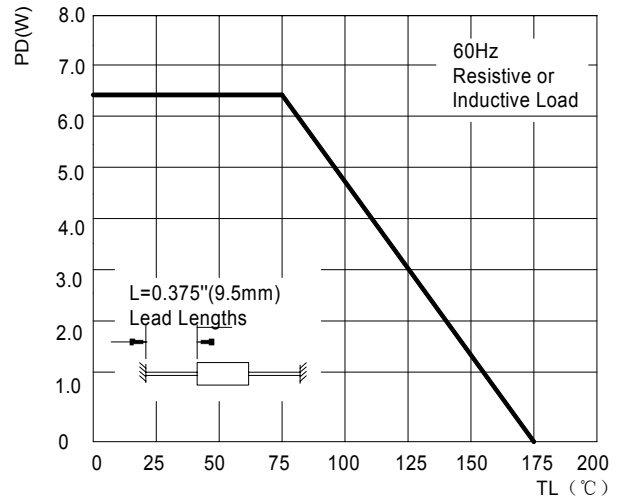

FIG5: Maximum Non-Repetitive Surge Current

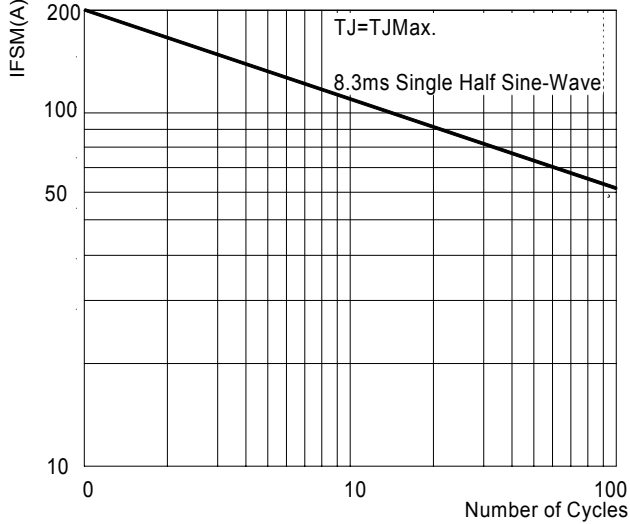
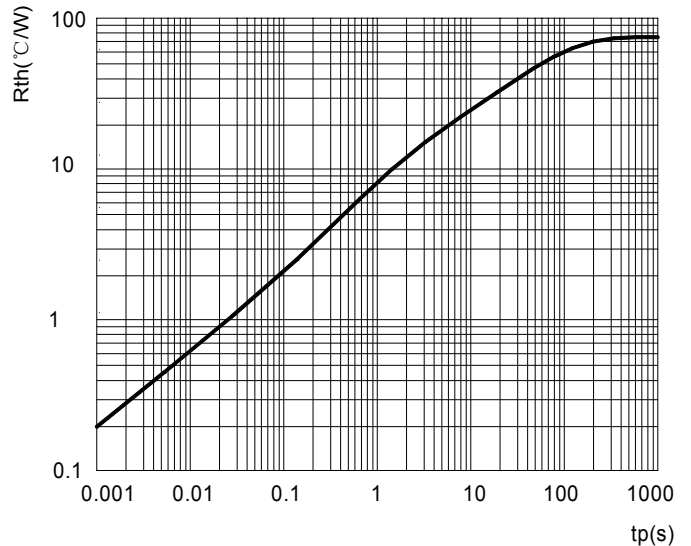
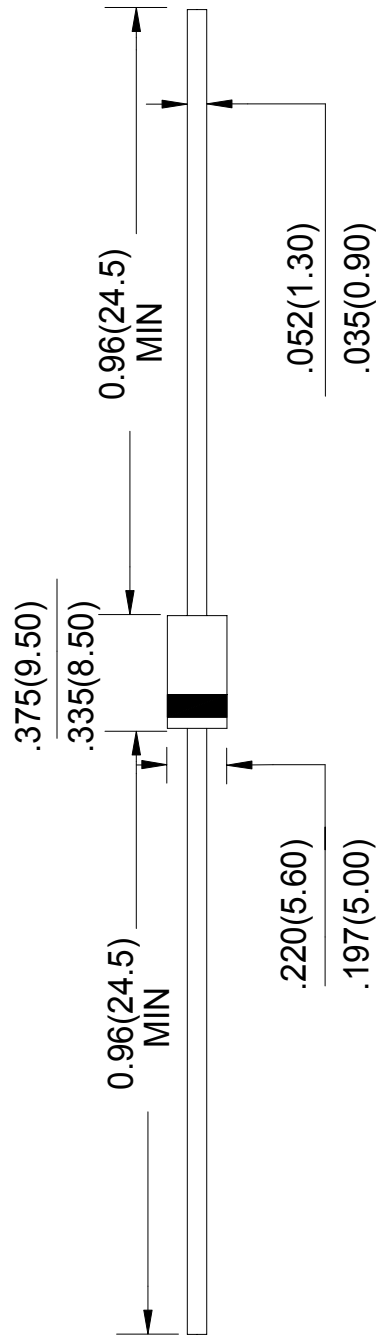

FIG6: Typical Transient Thermal Impedance





Unit: in inches (millimeters)

NOTICE

JSCJ reserves the right to make modifications, enhancements, improvements, corrections or other changes without further notice to any product herein. JSCJ does not assume any liability arising out of the application or use of any product described herein.

Ammo Box Packaging Specifications For Axial Lead Rectifiers

Axial lead devices are packed in accordance with EIA standard RS-296-D and specifications given below

COMPONENT OUTLINE	COMPONENT PITCH A	INNER TAPE PITCH B	CUMULATIVE PITCH TOLERANCE
	$\pm 0.5\text{mm}(.020'')$	$+0.5\text{mm}(.020'')$	
R-1	5.0mm	26.0mm	2.0mm/20pitch
R-1	5.0mm	52.4mm	2.0mm/10pitch
A-405	5.0mm	26.0mm	2.0mm/20pitch
A-405	5.0mm	52.4mm	2.0mm/10pitch
DO-34/DO-35	5.0mm	26.0mm	2.0mm/20pitch
DO-34/DO-35	5.0mm	52.4mm	2.0mm/10pitch
DO-41	5.0mm	26.0mm	2.0mm/20pitch
DO-41	5.0mm	52.4mm	2.0mm/10pitch
DO-15	5.0mm	52.4mm	2.0mm/10pitch
DO-27	10.0mm	52.4mm	2.0mm/10pitch
R-6	10.0mm	52.4mm	2.0mm/10pitch

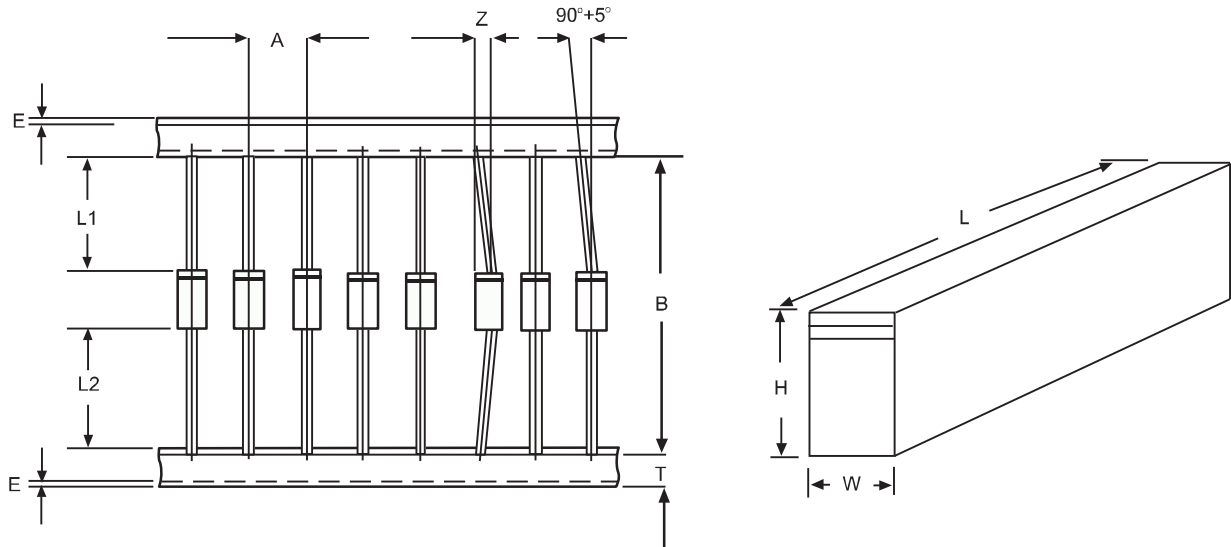

ITEM	SYMBOL	SPECIFICATIONS(mm)	SPECIFICATIONS(inch)
Component alignment	Z	1.2max	0.048max
Tape width	T	6.0 ± 0.4	0.236 ± 0.016
Exposed adhesive	E	0.8max	0.032max
Body eccentricity	$ L1-L2 $	1.0max	0.040max
Box length	L	255.0 ± 5.0	10.04 ± 0.197
Box width	W	78.0 ± 5.0	3.07 ± 0.197
Box height	H	150.0 ± 5.0	5.91 ± 0.197

NOTE: Each component lead shall be sandwiched between tapes for A minimum of 3.2mm(0.126'')